

# ACCESSORY GUIDE: MS-890

## Mounting Kits

Mounting Arm:  
98-000018-01

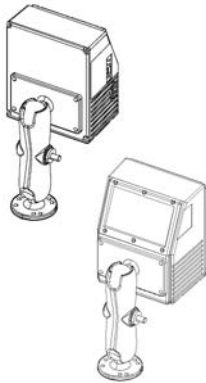

## IB-890 Interface Box

99-420003-04

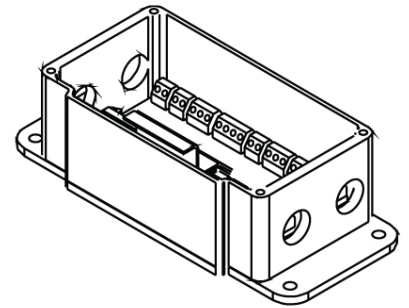

Base Plate: 98-000046-01  
(scanner and arm are sold separately)

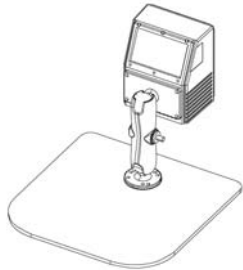

Mounting Plate: 98-200037-01

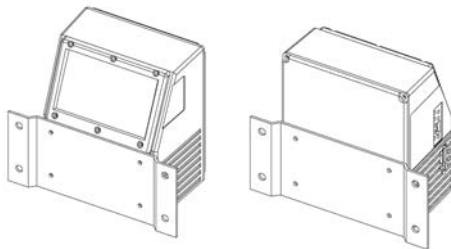

## Replacement Window Kits

Glass: 98-000011-01

Plastic: 98-000011-02

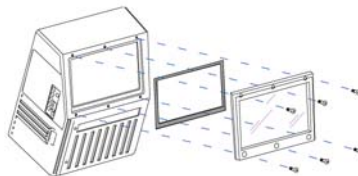

## Pluggable Relay Modules, Cable Grommet (CGB)

12-000130-01

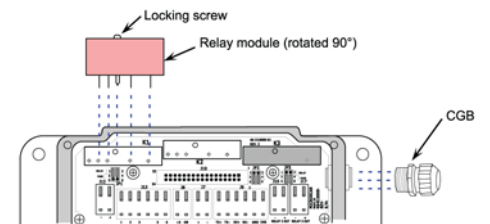

## Interface & Configuration Options

Communication Cable: 61-000010-02

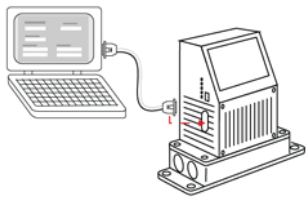

Daisy Chain Cable: 61-100029-03

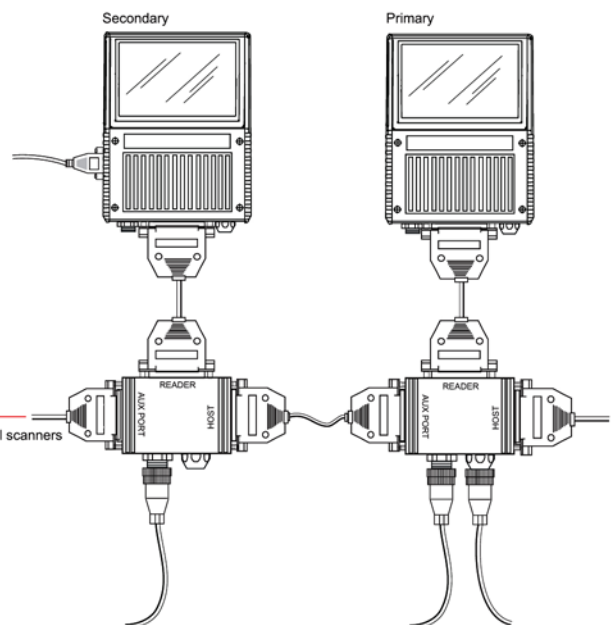

Multidrop Cable: 61-000122-01

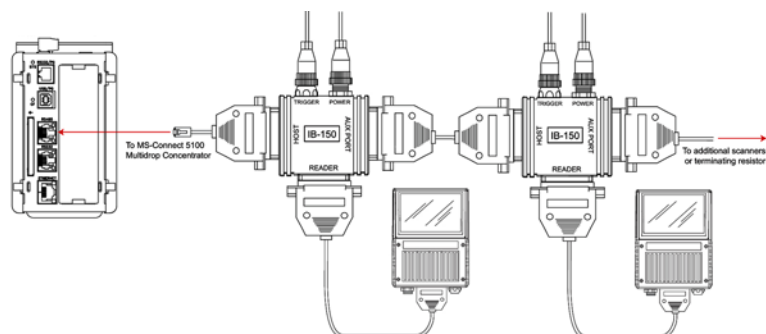

# MS-890 ACCESSORIES

MOUNTING & ACCESSORIES		
Accessory	Microscan Part Number	Description
IB-890 Interface Box	99-420003-04	Optional wiring accessory houses the network protocol card, relay modules, and allows for hard wiring to many different devices.
CGB Cable Grommet	12-000130-01	Secures all wires routing from the IB-890 to the external environment. One CGB comes with each IB-890 purchase.
Relay Modules	98-000013-04 (120 VAC) 98-000013-05 (240 VAC) 98-000013-06 (24 VDC)	Controls AC or DC voltage, up to 3 Amps of current. The IB-890 houses the relays.
Replacement Window Kits	98-000011-01 (Glass) 98-000011-02 (Plastic)	Glass is the standard option. Plastic windows conform to food industry requirements.
Mounting Arm Kit (6" / 152 mm)	98-000018-01 (MS-890) 98-000017-01 (IB-890)	A highly adjustable mounting arm utilizing ball and socket connections. This allows the arm to be positioned in almost any direction.
Base Plate Kit	98-000046-01	Plate for desktop presentation, 12" by 12" (304.8 mm by 304.8 mm).
Mounting Plate Kit	98-200037-01	Extends beyond the scanner surface with through holes for easy mounting to flat surfaces.
CABLE OPTIONS		
Host Cable	61-100034-02	DB-25 socket to DB-9 socket, 6' (1829 mm), RS-232 serial connection
Communications Cable	61-000010-02	DB-25 socket to DB-9 socket, 6' (1829 mm)
Daisy Chain Cable	61-100029-03	For use in daisy chain set-up, 1' (305 mm)
Multidrop Cable	61-000122-01	For use in multidrop network. For full multidrop configuration see the MS-Connect 5100.
POWER & SENSOR OPTIONS		
Power Supply	97-100004-15 (US/Euro plug, 24 VDC)	Use with IC-332
Object Detector	99-000004-01 (Terminated) 99-000004-02 (Unterminated) 99-000017-01 99-000017-02	Package detector Package detector Photo sensor, visible, NPN, DARK ON Photo sensor, visible, NPN, LIGHT ON
DOCUMENTATION		
ESP® Software, Tools CD	37-000001-01	User Manuals and ESP software (1 copy free per order)

©2013 Microscan Systems

www.microscan.com