

Quick Start Guide MS-4X Imager Series



MICROSCAN.

P/N 83-110444 Rev B

Step 3 — Position Imager

- Place the imager and test symbol in a location with as little ambient light as possible.
- Position the imager at a distance from the symbol that matches the factory pre-set focal distance. If your imager is pre-set at 4" (Standard Density), position the parting line 4" from the symbol. If your imager is pre-set at 3" (Low Density), position the parting line 3" from the symbol.
- Tip the imager relative to the symbol to avoid glare from specular reflection. Avoid excessive skew or pitch. Maximum skew is $\pm 30^\circ$; maximum pitch is $\pm 30^\circ$.
- Symbols can be rotated (tilted) at any angle; however, for best results symbols should be aligned with the FOV (field of view). In the case of linear symbols, aligning the bars in the direction of their movement ("ladder" orientation) will minimize the chances of blurring and No Reads.

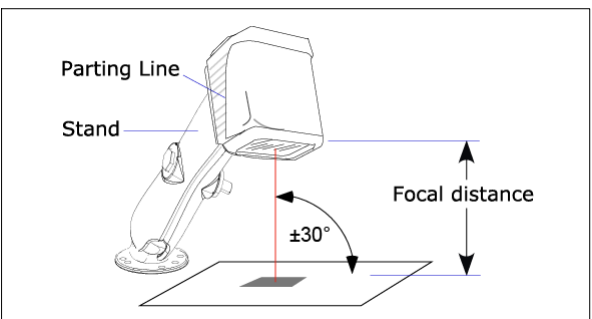

Imager / Symbol Positioning

Step 1 — Check Hardware

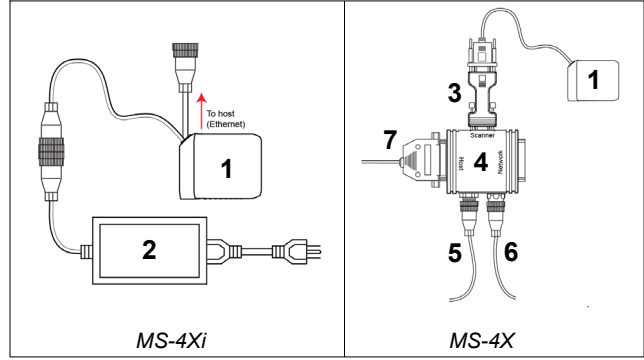

Hardware Required

Item	Description	Part Number
1	MS-4X, MS-4Xi	FIS-1004-1X10G
2	Power Supply, M12 12-pin Socket, 1.3 m (Screw-On) (MS-4Xi only)	97-000003-03
3	IC-332 Adapter	FIS-0001-0035G
4	IB-131 Interface Box	99-000018-01
5	Power Supply (90-264 VAC, 24VDC, USA/Euro plug)	97-100004-15
6	Object Detector	99-000017-01
7	Communication Cable	61-300026-03

Step 4 — Install ESP

ESP Software can be found on the Microscan Tools Drive that is packaged with the imager.

- Follow the prompts to install ESP from the Tools Drive.
- Click on the ESP icon to run the program.



Note: ESP can also be installed from the **Download Center** at www.microscan.com.

Refer to the user manual for detailed information about using ESP to configure the imager.

Minimum System Requirements

- 233 MHz Pentium PC
- Windows 8, 7, Vista, or XP operating system (32-bit or 64-bit)
- Internet Explorer 6.0 or higher
- 128 MB RAM or greater
- 160 MB free disk space
- 800 x 600 256 color display (1024 x 768 32-bit color recommended)

Step 2 — Connect the System

MS-4Xi – Ethernet

- Connect the M12 (power and I/O) end of the imager's cable to the power supply (2).
- Connect the RJ45 (Ethernet) end of the imager's cable to the host.
- Plug in the power supply to apply power to the imager.

MS-4X – RS-232 / RS-422

- Connect the imager (1) to the IB-131/IC-332 interface (4) and (3).
- Connect the communication cable (7) to the host, and to the host port on the IB-131.
- Connect the object detector (6) to the IB-131.
- Connect the power supply (5) to the IB-131.
- Plug in the power supply to apply power to the imager.

MS-4X – USB

- Plug the imager's USB cable into the host's USB port. The imager is powered by the USB connection.

Caution: Be sure that all cables are connected **BEFORE** applying power to the system. Always power down **BEFORE** disconnecting any cables.

Step 5 — Select Model

When you start ESP, this menu will appear:

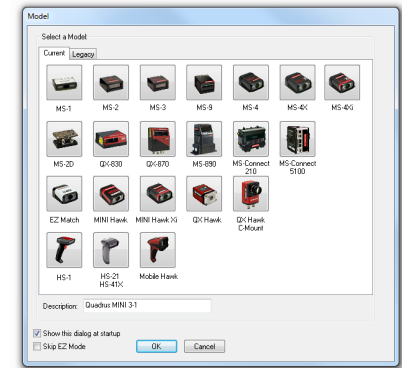

- Click the button showing the imager used in your application.
- Click **OK**.
Note: You can also simply double-click the button showing your imager to make your selection.
- Click **Yes** when this dialog appears:



Note: If you need to select another model later, click the **Switch Model** button near the top of the screen or use **Model > New Model** in the menu toolbar.

Step 6 — Connect

To connect using the Connection Wizard:

- Click **Connect** on the menu toolbar, and then select **Connection Wizard**.
- Select the communication interface required by your application.
- Configure settings as required by the application, and click **Connect**.

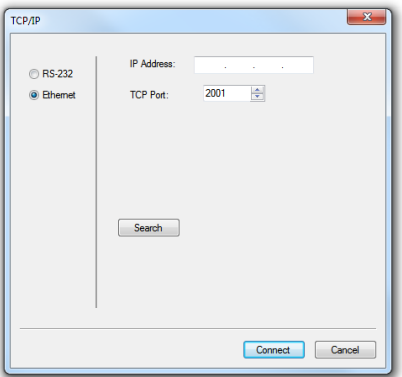

- When a connection is established, the green indicator in the status bar at the bottom right of the screen will be visible:

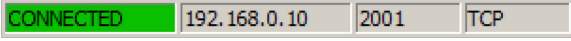

Important: The imager is in **Continuous Read Mode** by default. For best connection results, be sure that no decodable symbols are within the imager's field of view while attempting to connect.

Step 7 — Locate the Symbol

Locate by ESP

- In **ESP's EZ Mode**, click the **Locate** button to enable the blue target pattern. The symbol in the field of view will appear in the video view beneath the **Locate** and **Calibrate** buttons, and you will see the blue target pattern projected from the front of the imager.
- Center the target pattern on the symbol.

At 2 to 3 inches, the pattern resembles an **X**. At 3 to 6 inches, the pattern resembles a **V**.
Important: The entire symbol should fall within the field of view (FOV) of the imager. The field of view is what appears in **ESP's Locate/Calibrate** window in **EZ Mode**.

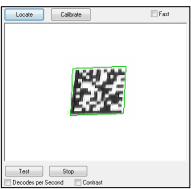

- Click the **Stop** button to end the **Locate** function.

Locate by EZ Button

If you are not connected to a host computer, the EZ Button allows you to locate the symbol in the imager's field of view.

- Hold down the EZ Button for about one second and release when you hear one short beep. The amber **20%** LED will illuminate, and you will see the blue target pattern projected from the front of the imager.
- Center the target pattern on the symbol.

Note: To end all EZ Button functions, press the EZ Button once and quickly release.

Step 8 — Calibrate

Imager settings can be adjusted automatically for optimum performance by either the EZ Button or by **ESP**. During the calibration routine, the imager will flash its Read Rate percent LEDs and illumination LEDs while searching camera settings and determining the best configuration for decoding symbol data. Upon successful completion of this routine, a green LED pattern will flash brightly and illuminate the symbol. If unsuccessful, the imager will emit 5 short beeps and stop searching.

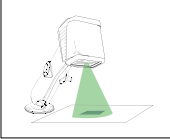

Calibrate by EZ Button

- Hold down the EZ Button for about two seconds and release when you hear **two short beeps**. The **20%** and **40%** LEDs will illuminate.
- The imager will search camera settings to determine the best configuration for decoding symbol data.
Note: To end all EZ Button functions, press the EZ Button once and quickly release.

Calibrate by ESP

- Click the **Calibrate** button.
- The imager will search camera settings to determine the best configuration for decoding symbol data.
 A successful calibration will display a green frame around the symbol, and the following message will appear: "Uploading all reader parameters." After a moment the symbol data will be presented in the field below the image display window.

Calibrate by Serial Command

Send **<@CAL>** from a terminal program to begin calibration.

Step 9 — Test Read Rate

Read Rate indicates the number of successful decodes per second achieved by the imager.

Test Read Rate by EZ Button

- To start the Read Rate test, hold down the EZ Button about three seconds until you hear **three short beeps**. The **20%**, **40%**, and **60%** LEDs will illuminate. While the object is being inspected, the Read Rate LEDs will indicate the read rate percentage on the back of the unit.
- To end the Read Rate test, press the EZ Button and quickly release.



MS-4X Read Rate LEDs and EZ Button

Test Read Rate by ESP

- Click the **Test** button to start the Read Rate test and **Stop** to end it.



If a symbol has been successfully decoded, its data and related features will be presented in the field below the image display window. Also, while the object is being inspected, the Read Rate LEDs will indicate the Read Rate percentage on the back of the unit.



MS-4Xi Read Rate LEDs and EZ Button

- To end the test, click the **Stop** button.

Note: Read Rate can also be tested using the **Read Rate** interface in **Utilities**.

Test Read Rate by Serial Command

You can also start a test with the **<C>** or **<Cp>** command and end it with the **<J>** command.

Step 10 — Configure and Save

Click the **App Mode** button to make configuration changes to the imager.



The following modes are accessible by clicking the buttons at the top of the screen:

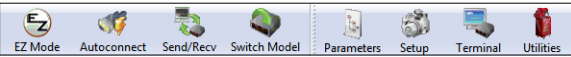

- Click the **EZ Mode** button to return to EZ Mode.
- Click the **Autoconnect** button to establish communication.
- Click the **Send/Recv** button to send or receive commands.
- Click the **Switch Model** button to open the model menu, or to return to a previous model.
- Click the **Parameters** button to show the tabbed tree controls for Communication, Read Cycle, Symbologies, I/O Parameters, Symbol Quality, Matchcode, and Diagnostics.
- Click the **Setup** button to access a Camera Setup tree control and Video view, Evaluate image captures, Calibrate the imager, set the Window of Interest, load capture settings and processing settings in the Configuration Database, set up output filters and parse symbol data in Ordered Output and Output Format, and control multiple read cycle functions in Dynamic Setup.
- Click the **Terminal** button to display decoded symbol data, and to send serial commands to the imager using text or macros.
- Click the **Utilities** button to test Read Rate, request or clear Counters, enable or disable the imager or send output pulses in Device Control, determine the Differences from Default in the current settings, add or remove master symbol data in Master Database, and verify or update the imager's Firmware.

Step 11 — Save Changes in ESP

To make changes to a configuration setting:

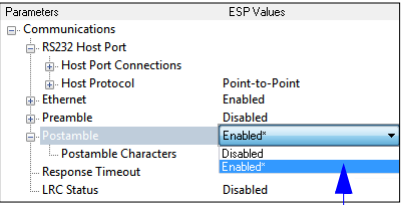
- Left-click** on the **+** to expand the desired tree.
- Double-click** on the desired parameter and click once in the selection box to view options.

- Place your cursor in the selection box, scroll down to the setting you want to change, and **click** once on the setting.
- Left-click** again on the open screen to complete your selection.
- Right-click** on the open screen and select **Save to Reader** to implement the command in the imager.

Saving Options

- Send, No Save.** Changes will be lost when power is re-applied to the imager.
- Send and Save.** This activates all changes in current memory *and* saves to the imager for power-on.