

NERLITE SMART SERIES RING ILLUMINATORS

CONFIGURATION GUIDE



PART NUMBER	DESCRIPTION	Current Draw @ 24VDC (max.)	Continuous Mode	Continuous Mode With Dimming Or On-Off Control	High Output Strobe Mode
			No Controller Required (Can Be Connected Directly To 24VDC)	No Controller Required (Can Be Connected Directly To 24VDC)	No Controller Required (Can Be Connected Directly To 24VDC)
NER-011660800G	SMART SERIES R-60, RED	1.20A	Figure A or D	Figure B	Figure C
NER-011660810G	SMART SERIES R-60, WHITE	0.70A	Figure A or D	Figure B	Figure C
NER-011660820G	SMART SERIES R-60, BLUE	0.70A	Figure A or D	Figure B	Figure C
NER-011660840G	SMART SERIES R-60, ULTRAVIOLET	0.23A	Figure A or D	Figure B	Figure C
NER-011660900G	SMART SERIES R-70, RED	1.20A	Figure A or D	Figure B	Figure C
NER-011660910G	SMART SERIES R-70, WHITE	0.85A	Figure A or D	Figure B	Figure C
NER-011660920G	SMART SERIES R-70, BLUE	0.85A	Figure A or D	Figure B	Figure C
NER-011661100G	SMART SERIES R-100, RED	1.70A	Figure A or D	Figure B	Figure C
NER-011661110G	SMART SERIES R-100, WHITE	1.10A	Figure A or D	Figure B	Figure C
NER-011661120G	SMART SERIES R-100, BLUE	1.10A	Figure A or D	Figure B	Figure C

Hardware Required

Item	Description	Part Number
1	Smart Series Ring Lights	NER-011660XXXG
2	Power Supply DSP60 24VDC 2.5A DIN Mount	NER-011504100
2	Power Supply DSP100 24VDC 4.2A DIN Mount	97-000006-01
3	Cable 5 Pin M12 Female To Flying Leads, 3M	61-000186-01
3	Cable 5 Pin M12 Female To Flying Leads, 5M	61-000187-01
4	Cable, Power Smart Series to QX-1	61-000204-01

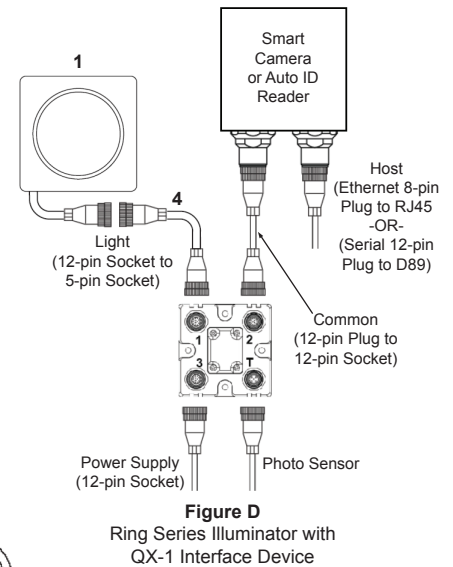
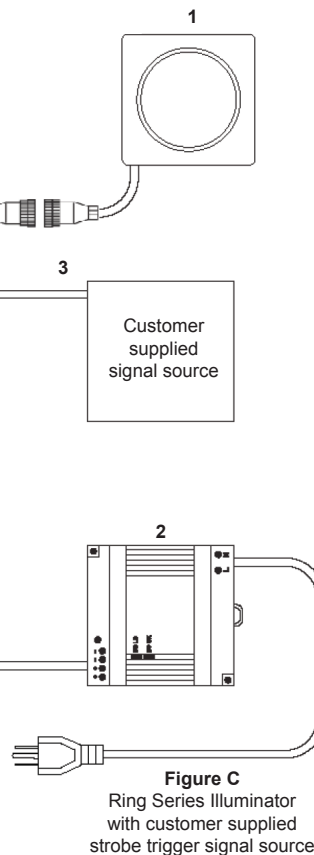
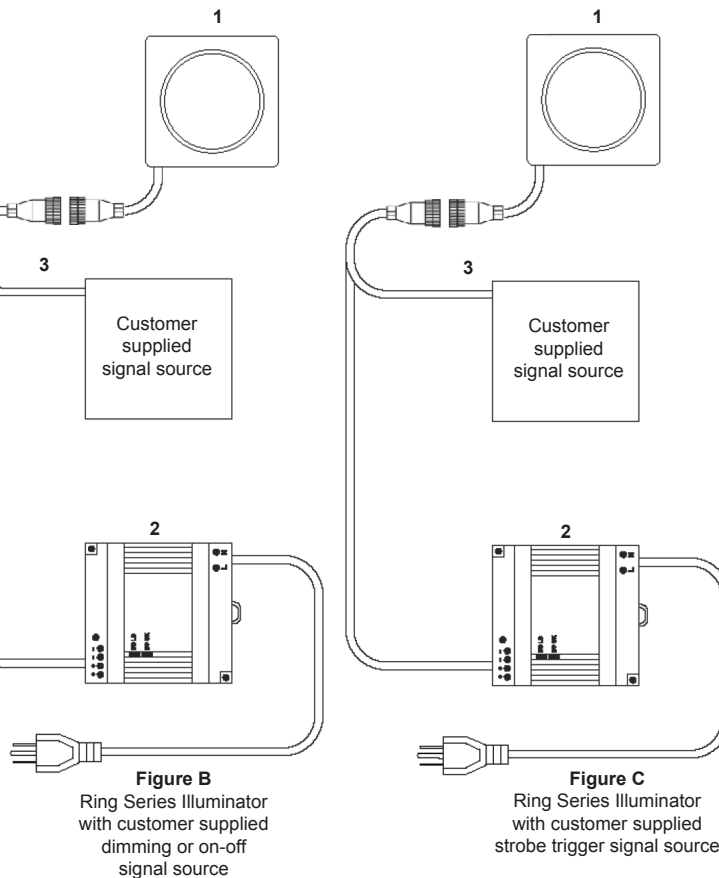
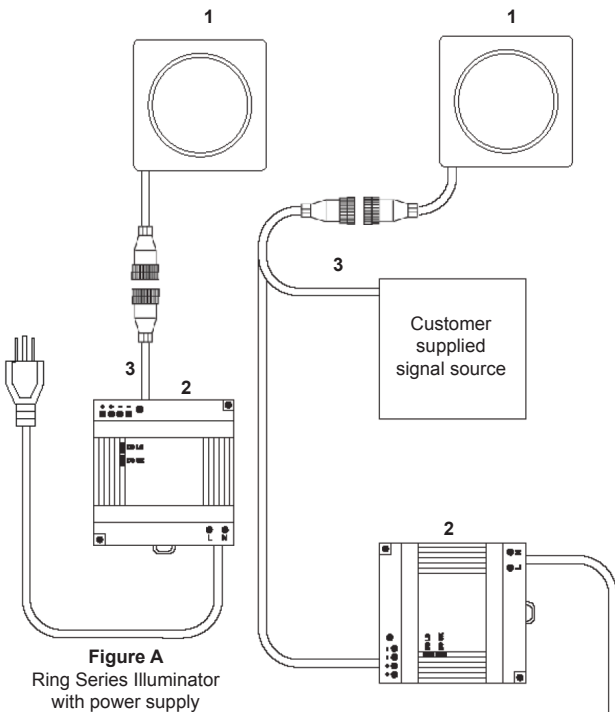

Accessories

Description	Part Number	Application
AC Power Cord US	NER-030028300	Power Cord For Power Supply
AC Power Cord EU	NER-030028400	Power Cord For Power Supply
AC Power Cord UK	NER-030028500	Power Cord For Power Supply

Connections:

Input Connector (M12 Male, 5 Circuit, A-Code)	Pin 1	Pin 2	Pin 3	Pin 4	Pin 5	Backshell
Continuous Mode (Figure A & D):	+20.2-28.8VDC	DC GND	DC GND	+20.2-28.8VDC	No Connection	Shield
Continuous Mode With Dimming (Figure B):	+20.2-28.8VDC	DC GND	DC GND & DIM (-)	+20.2-28.8VDC	Dim (+)	Shield
Continuous Mode With On-Off Control (Figure B):	+20.2-28.8VDC	DC GND	DC GND & DIM (-)	+20.2-28.8VDC	Dim (+)	Shield
High Output Strobe Mode (Figure C):	+20.2-28.8VDC	TRIG (-)	DC GND	TRIG (+)	No Connection	Shield

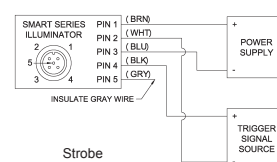
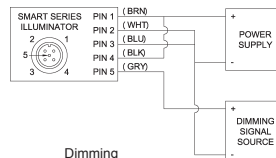
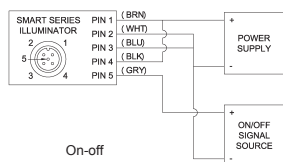
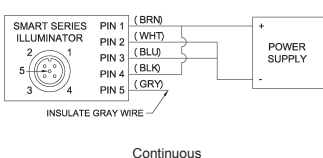

Control Signals

DIM (Continuous Mode With PWM Dimming):

0VDC (LEDs off) to 3.1-3.5VDC (LEDs on) pulse width modulated (PWM) signal, <1mA, Modulation Frequency 2KHz +/- 100Hz

Note: When using Continuous Mode With Dimming, the LED duty cycle will equal the duty cycle of the dimming signal.

DIM (Continuous Mode With On-Off Control): 0VDC (LEDs off), 3.1-3.5VDC (LEDs on), (<1mA)

TRIG (High Output Strobe Mode):

optoisolated, 0VDC (LEDs off) to 3.1-28.8VDC (LEDs on), 10mA max, 20 μs min Trigger pulse width. Note: High Output Strobe internally limits LED frequency and pulse width to a maximum of 90Hz and 1ms respectively. Light output pulse will follow Trigger pulse width from 20 μs to 1ms.

Note: When using Continuous Mode With Dimming, the LED duty cycle will equal the duty cycle of the dimming signal.

Cable Specifications:

Wire colors for flying lead cables:

- Pin 1 = Brown
- Pin 2 = White
- Pin 3 = Blue
- Pin 4 = Black
- Pin 5 = Gray
- Connector Nut = Shield

Note: Non-Omron Microscan cables may use different wire colors. It is the customer's responsibility to make sure the light is connected correctly per the pin numbers in the table above.